

# Fast, Robust and Versatile Humanoid Robot Locomotion with Minimal Sensor Input

Dorian Scholz, Martin Friedmann, Oskar von Stryk

*Simulation, Systems Optimization and Robotics Group  
Technische Universität Darmstadt*

*Hochschulstr. 10, 64289 Darmstadt, Germany*

{scholz | friedmann | stryk} @sim.tu-darmstadt.de

**Abstract**—The generation of fast and robust locomotion is one of the crucial problems to be solved for a competitive autonomous humanoid soccer robot. During the last decades many different approaches to solve this problem have been investigated.

In this paper a simplified yet powerful approach for generation of locomotion for an autonomous humanoid robot is described. It is based on an open loop trajectory generation with an overlying gyroscope-based closed loop postural stabilization.

Unlike other widely used approaches in humanoid robotics the trajectory generation is completely decoupled from the stabilization algorithm, thus simplifying design, implementation and testing of either algorithm.

The only sensor required for postural stabilization is a two axis gyroscope in the robot’s hip. No further sensors like foot-ground contact or force sensors, which are typically applied in many other approaches, are required. Nevertheless the presented approach exhibits remarkable performance. Furthermore this approach can be implemented easily in many available robots without complex modifications of the hardware.

Experimental results for various types of locomotion are presented for two different robots used in the 2009 RoboCup Humanoid KidSize competition.

## I. INTRODUCTION

In competitive dynamic environments like a RoboCup soccer match versatile, fast and robust locomotion is one of the keys to a successful robot. Such locomotion must fulfill different requirements. In case the ball is far away, the robot must be able to cover large distances in a short time. If the robot is close to the ball and needs to manipulate the ball, e. g. by kicking it towards the goal or dribbling it, not only a variety of kicking motions are required but also the flexibility to position the robot into a good kicking position. During all motions of the robot it is highly desirable that the robot remains stable. This is especially true for soccer playing robots, as the highly unpredictable state of the world leads to many accidental contacts between robots of the same as well as of the opposing team.

A wide variety of techniques have been used to generate walking motions for humanoid robots and to maintain their stability. Postural stability of a robot’s motion is often improved by using sensor feedback into the online-motion-generation. Different sensors like gyroscopes or feet-ground contact force sensors may be used for this purpose.

In this paper a motion generation system for humanoid robots is presented which is able to generate motions fulfilling

all of the previously stated requirements. The system has two central merits: it decouples the generation of the primary walking motions from the sensor stabilization and it uses only two gyroscopes for stabilization. These facts not just simplify implementation a great deal, they also allow easy adaption of the system to other robots. As the stabilization does not make assumptions on the generation of the walking motion, it can be used with others as the proposed methods and thus be added to existing robots. As it only uses two gyroscopes in the robots trunk (where usually the robot’s computers are situated), it can be easily implemented in a robot without the need to install further sensors (like feet-ground contact force sensors) at places that require complicated wiring.

Many humanoid robot’s feature a leg structure containing 6 degrees of freedom (DoF) per leg. This allows for free positioning and orientation in three dimensional space and thus gives the robot the ability to move it’s feet on arbitrary trajectories. An example of a robot with such a kinematic structure is the humanoid robot Bruno[1] which is one of the platforms used in this paper.

The motion generation system described in the paper is an extension of the one from [2]. Although the software has been completely rewritten, some of the central concepts are still in use. Furthermore the system has been ported to the newer robot DD2008, which was a key figure in the recent victorious participation of the Darmstadt Dribblers at the RoboCup competition.

The remainder of this paper is structured as follows: After a presentation of related work on stability of humanoid robot locomotion and motion generation in section II and a brief discussion of the robots used in section III, the developed motion-generation and -stabilization techniques are described in section IV. In section V the capabilities of the motion generation are evaluated in experiment. Special focus is laid on the impact of the closed-loop stabilization. The paper concludes with a summary and an outlook.

## II. RELATED WORK

Postural stability of legged robots has been researched for many years, leading to several concepts of and criteria for stability. A robot’s motion is said to be *statically stable* if it can be stopped during any phase and the robot will not fall over. A criterion for static stability is the orthogonal projection of the

robot's center of gravity (PCoG) lies within the robot's support polygon[3]. As static stability only allows for relatively slow motions, another concept, namely *dynamical stability* has been introduced. Dynamically stable motions may not be interrupted at arbitrary times, but allow for faster motions. A widely used criterion for dynamically stable locomotion is the zero-moment-point (ZMP)[4]. The ZMP is the point on the ground plane where the moment resulting from all moments and forces acting on the robot disappears in the components parallel to the plane (there may be a moment orthogonal to the plane). If the ZMP remains within the support polygon during a motion, the robot will not fall over even when the PCoG leaves the support polygon. Another criterion is the foot-rotation-indicator point (FRI)[5]. This is the point on the ground plane, where the resulting ground contact forces need to act to avoid motion of the standing foot. As long as the FRI-point is within the support polygon, the robot will remain stable during a motion. If it leaves the support polygon, it can be used as a measure for the instability of the current state of the robot.

Based on the above criteria stable motions for a humanoid robot can be planned using a model of the robots dynamics resp. kinematics, e. g. [6], [7]. Due to the underlying modeling of the robot these approaches are computationally complex. To avoid this complexity often approaches without a model or simplified models are used. An approach for a simplified dynamics model is the inverted pendulum, where the robot is modeled as a point of mass balancing on a stick. A common approach describing legged motion without the need for a model is the central-pattern-generator (CPG), e. g. [8]. The CPG derives all time dependent variables of a motion from a common clock, thus leading to a repeating pattern of motion. Independent of the generation of the basic motion patterns of the robot, often additional measures are taken for the online stabilization of the robot's motion based on sensory feedback.

Several combinations of motion generation and feedback-control of the robot's stability have been investigated and used successfully for soccer playing humanoid robots.

The humanoid robot's gait that is used in [9] is based on a CPG generating trajectories for the robot's feet and upper body in Cartesian space, subsequently using inverse dynamics to calculate the required joint angles for the motion. The approach uses no further sensory feedback and thus is completely open-loop.

The omni-directional motion generation described in [10] is based on a CPG controlling the extension and direction of the robot's legs. It is extended by feedback control to improve speed and stability of the motions in [11]: Feedback from two gyroscopes is used to alter the orientation of feet and upper body in order to avoid angular motion of the robot's upper body. Ground-contact-sensors are used to reset the phase of the CPG in order to synchronize the CPG with the robot's motion.

Another approach for humanoid robot locomotion is the passive dynamic walking where the energy of the height of the centre of mass (CoM) is used to drive the locomotion down a slope. To be suitable for the task of robot soccer playing

on a level field energy has to be pumped into the system using for example servo motors. But the servo motors' gears introduce a high damping onto the joints and therefore are quite disadvantageous for the main effect in passive dynamic walking, the preservation of the energy of the CoM. In [12] a system is described that tries to overcome this by reducing the stiffness of the servo motors and using them as sensors as well as actuators.

In [2] a motion generation which serves as the base for this paper is described. It uses pre-calculated tables for the motion of the robot's feet and hip which satisfy the ZMP criterion for an inverted pendulum model of the robot and an additional stabilization based on two gyroscopes. Walking motions are limited to forward, backward and sideways motions with optional turning. For each direction distinct parameter sets further describing the motion are applied.

### III. HUMANOID ROBOT PLATFORMS

For the research presented in this paper two generations of humanoid robots used in the authors' RoboCup team have been used. Both types are based on robots developed in cooperation with the Hajime Research Institute<sup>1</sup> which have been extended by an embedded PC, a camera, wireless communications and batteries. The robots have a similar kinematic design (see Fig. 1), but differ in size, weight, mass distribution and the servo motors used (see Tab. I).

Computation capabilities of the robots are distributed among two distinct units (see Fig. 2). For high-level tasks like image-processing, world-modeling and behavior-control an embedded PC is used [1]. The embedded PC is connected to a camera for external perception and a wireless network adapter for team communication.

For real-time motion-generation and -stabilization an additional microcontroller-unit is used. It is connected to the embedded PC by an RS232 serial line and to the servos motors using one resp. two RS485 connections. Inertial sensors which are used for motion stabilization and detection of falling are connected to the microcontrollers A/D converters. The microcontrollers used in both types of robots significantly differ in their computation and communication capabilities. Details on the controllers and sensors used are summarized in Tab. I.

### IV. MOTION GENERATION

The motion generation is divided into multiple modules, where each module contains a specific motion task. These modules can be executed in a prioritized manner so that modules of high priority can alter or overwrite the output of the ones with lower priority (Fig. 3).

It has to be distinguished between two groups of motion modules, the open-loop modules where the output is completely sensor independent and the closed-loop modules which rely on sensor input. The former consists of the modules for walking trajectory generation, special actions (i.e. kicking and

<sup>1</sup><http://www.hajimerobot.co.jp/>

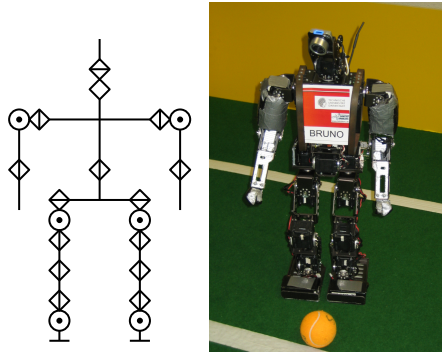

Fig. 1. Left: Kinematic structure of the robots. Right: Humanoid Robot Bruno (DD2008 model).

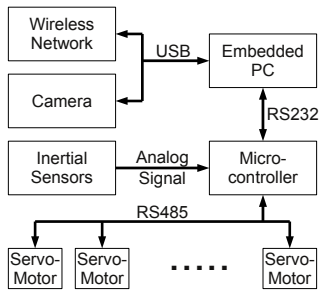

Fig. 2. Integration of the robot's computers, sensors and servo-motors.

TABLE I  
TECHNICAL DATA OF THE ROBOTS.

Robot	DD2007	DD2008
Main structure		
Based on	HR18	HR30
Height [cm]	55	57.5
Mass [kg]	3.3	3.5
Size of Feet [cm x cm]	12.5 x 8.0	14.3 x 7.5
Drives		
DOF	21	21
Servomotors	3 x RX64 18 x DX117	3 x RX64 18 x RX28
Operating Voltage [V]	15.3	19
Motion Controller		
CPU	Renesas SH2/7145 50MHz 1MB Ram	Renesas SH2/7211 160 MHz 16MB Ram
Gyroscope	3 x Silicon Sensing CRS03	3 x Silicon Sensing CRS03
Accelerometer	Crossbow CXL04LP3 (3 axis)	ADXL330 (3 axis)
Communication	RS232 (57.6 kBit/s) RS485 (500 kBit/s)	RS232 (57.6 kBit/s) 2 x RS485 (1MBit/s)

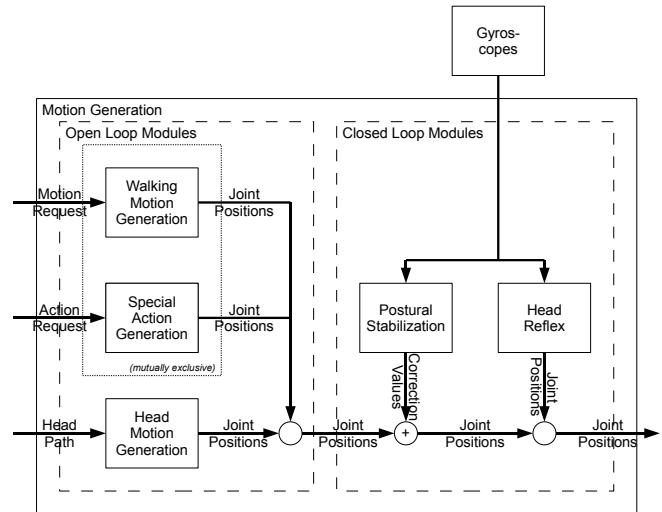

Fig. 3. Structure of the motion generation. At empty circles joint positions coming from above may override joint angles coming from the left.

get-up motion) and head motion generation. The latter includes a module for postural stabilization based on gyroscope input and one for a head reflex executed in case of a fall based on accelerometer input.

During locomotion the walking trajectory generation and the head motion generation are executed with the lowest priority, overlain by the the postural stabilization and the head reflex module.

In this paper we focus on robust and versatile locomotion, but the stabilization module is also used during execution of special actions without any change in parameters.

#### A. Walking Trajectory Generation

The approach of pre-calculating the movement along the y-axis so it is compliant with the ZMP criterion has been implemented as described in [2]. But the walking motion generation described in [2] is limited by relying on discrete motion generation for sideways and forward/backward movements that can not be combined, thus making it impossible to move in diagonal directions.

This has been avoided here by making no explicit selection between different types of trajectory generation depending on the walking direction. The changes in the walking trajectory generation for different directions are rather calculated by interpolating two parameter sets describing the foot trajectories for sagittal and lateral walking directions (Fig. 4). Thus making it possible to walk in any direction and also turn at the same time. Still it should not be called an omni-directional motion, since it can not move in all directions with the same top speed, which is further discussed in the results.

The parameter sets include the following values:

*stride time*

time for a stride

*foot ground time 1*

time the foot stays on the ground before the lift off

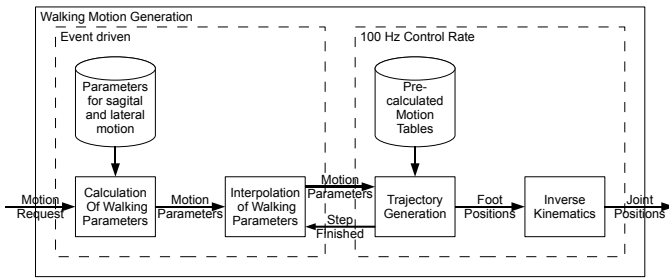

Fig. 4. Structure of the open loop walking motion generation.

*foot ground time 2*

time the foot has to be on the ground before the stride ends

*stride height*

maximum height of the swinging foot above the ground

*hip side amplitude*

maximum displacement of the hip towards the side of the supporting foot

To allow for smooth transitions to new walking requests there is another interpolation taking place between the current and the new walking direction and speed. It can take multiple strides to reach the new values depending on the difference in speed and direction between the two successive walking requests (Fig. 4).

This results in a set of dynamically adjusted parameters describing the maximum foot displacements relative to each other during one stride:

*stride length*

foot displacement along the x-axis

*stride width*

foot displacement along the y-axis

*stride rotation*

foot rotation around the z-axis

The foot trajectories are calculated in a Cartesian coordinate system with its origin in the point projected from the center of the hip perpendicular onto the ground plane. To calculate the foot positions at any given time  $t$  the stride length, width, rotation and height are multiplied with the factors from the respective motion tables (figures 5, 6, 7) for that time  $t$ .

The generated foot positions are translated into joint positions using an inverse kinematics calculation. This calculation is simplified by enforcing that the foot is always parallel to the robot's hip, thus only allowing the foot to rotate around its upward axis.

### B. Special Action

Special actions are used to implement non-walking-motions like kicking, getting up or the goalie jumps. They consist of a number of frames describing joint positions and a transition time to the next frame. In between frames the joint positions are interpolated. Each frame also names the id of the next frame to be executed, thus giving the possibility for loops.

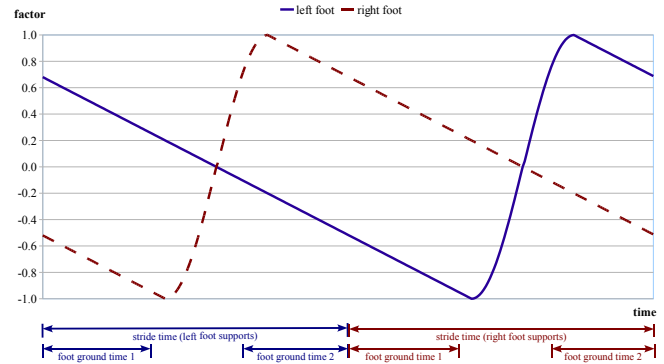

Fig. 5. X-Axis Motion Table: the factor to be multiplied with the stride length plottet over time for a double stride

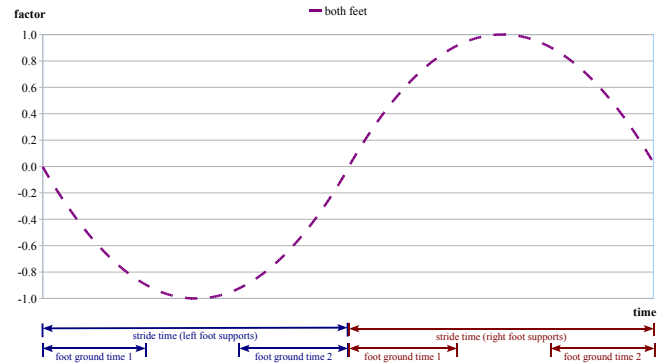

Fig. 6. Y-Axis Motion Table: the factor to be multiplied with the stride width plottet over time for a double stride

When a looping special action is to be stopped, it is allowed to come to a defined ending by attaching a second frame id that is to be executed when a cancel request has been received.

### C. Head Motion Generation

To allow the head to move continuously independent of the other currently active motion modules, the head motion has been implemented into a separate module that is always running at the lowest priority.

The implementation is analogous to the special action module, but here the frames only describe the two neck joints.

### D. Postural Stabilization

In postural stabilization the goal is to minimize the angular velocity of the upper body. Two gyroscopes located at the robot's hip are used to measure the angular velocity in pitch and roll direction. They are sampled at a rate of 750 Hz on the DD2007 and at 1500 Hz on the DD2008 and subsequently passed through a low pass filter to reduce noise. The filtered data is used as the error value for the PD-controllers that adjust the positions of the ankle, hip and shoulder joints in pitch and roll direction. Each of the controlled joints has its own hand tuned gains so that the PD-controllers output individual joint position correction values. These are added on top of the joint

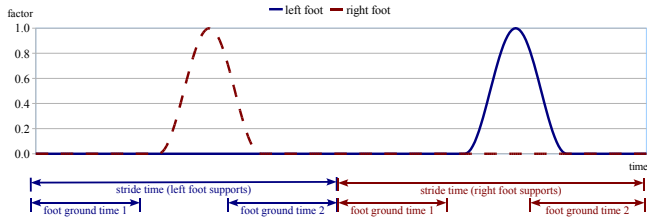

Fig. 7. Z-Axis Motion Table: the factor to be multiplied with the stride height plottet over time for a double stride

positions generated by the underlying motion module (i.e. the walking trajectory generation).

### E. Head Reflex

The directed vision system of the robots uses a camera with a small angle of view. Therefore it needs to tilt the camera over the edge of the upper body to be able to see the area directly in front of the robot. This bears the risk of breaking the camera when falling down while it is in this position. Therefore a head reflex has been implemented as a motion module of highest priority, pulling up the camera when a fall is detected. The fall detection is based on measuring the acceleration with the upward-axis accelerometer. When the measured value sinks more than a defined threshold below gravity the head reflex is triggered.

## V. RESULTS

To show the effect of the postural stabilization two experiments have been made. The first showing the direct effect by monitoring the gyroscope measurements during a disturbance with and without activated stabilization. The second demonstrating the impact of the stabilization on the maximum possible walking speeds.

Results of the the first experiment are only shown for the robot DD2008 as the difference here to the DD2007 is minimal. For the second experiment the results are shown for both models.

### A. Postural Stabilization

The robot is standing upright in its ready position with slightly bended knees. It is then tilted by 7 degrees out of its equilibrium and let go. This has been done tilting backwards and sideways once with and once without the stabilization module activated. The gyroscope measurements of the four experiments can be seen in Fig. 8 and Fig. 9 starting from the moment the robot was let go. They clearly show that the stabilization module helps the robot find back to its equilibrium more quickly than without it.

### B. Walking Speeds

The robots have been let run multiple times for a fixed number of steps. Each time the stride length has been increased until the robots failed to complete all the steps. For the longest few stride lengths the runs were repeated while increasing the stride time until again the robots failed to complete the

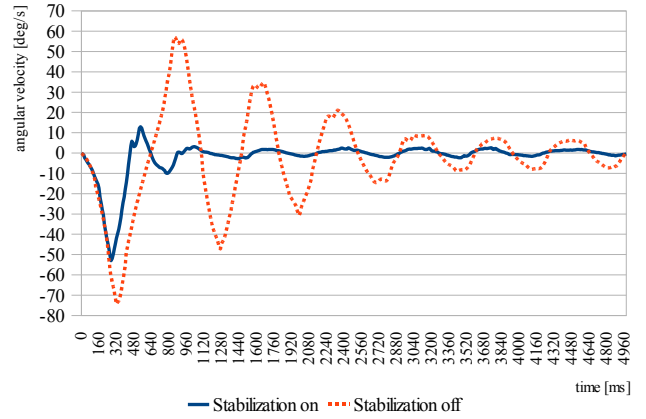

Fig. 8. Pitch Stabilization on a DD2008: angular velocity measured by the pitch axis gyroscope for 5 seconds

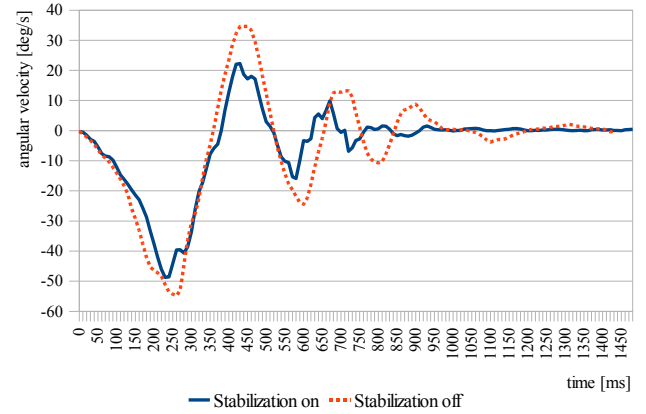

Fig. 9. Roll Stabilization on a DD2008: angular velocity measured by the roll axis gyroscope for 1.5 seconds

run. For each run the time and distance were recorded to calculate the robots' speed. This experiment was repeated for different walking direction each with and without the stabilization module activated.

The resulting maximum speeds can be found in Fig. 10 and Fig. 11 and clearly show the positive effect of the stabilization module. Also it can be seen from the dotted red lines marking the top speeds without the stabilization module, that the older model DD2007 can walk faster sideways and diagonally than the new DD2008. This is caused by the different foot length to width ratios (see Tab. I) of these two robot models.

When walking forward with the stabilization module turned on the robots reached top speeds of 39 cm/s (DD2007) and 43 cm/s (DD2008).

But the stabilization did not only increase the top speed, it also made walking at low speeds much more stable and precise by reducing the swinging motion of the robot. Hence also helping when positioning at the ball to do aimed kicks at the opponents goal.

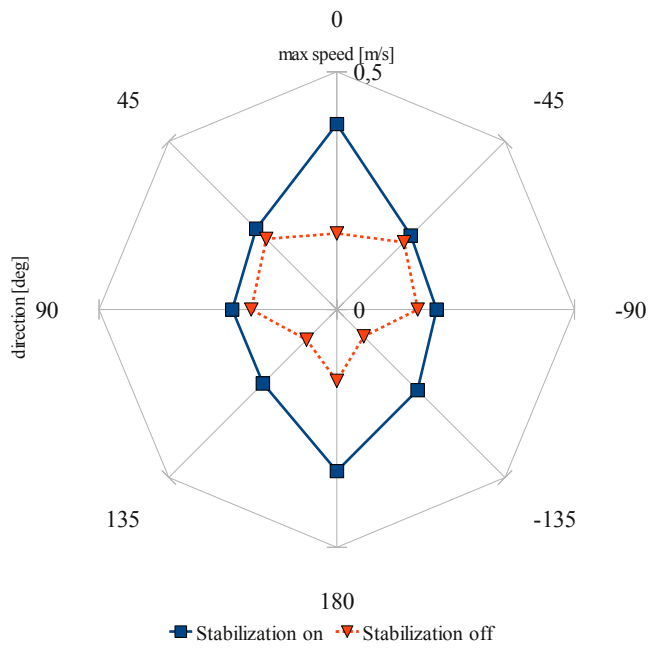

Fig. 10. Maximum Walking Speeds for DD2007

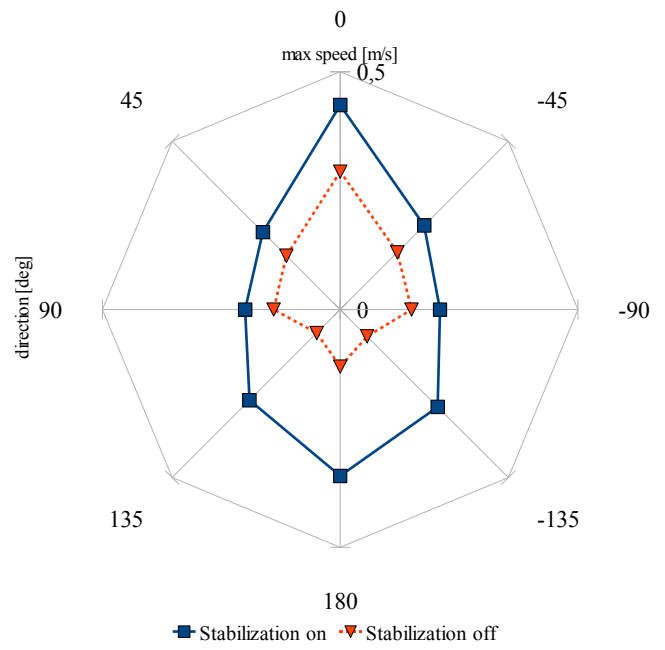

Fig. 11. Maximum Walking Speeds for DD2008

## VI. CONCLUSION AND OUTLOOK

In this paper the motion generation of the humanoid soccer robot models DD2007 and DD2008 has been described. It has been shown, that an open-loop walking motion can reach very high speeds when assisted by a closed-loop stabilization module.

The stabilization has been realized using two gyroscopes as the only input sensors. Also the stabilization module has been implemented in a way that it was not necessary to alter the walking motion generation and still gain a much higher walking speed. Furthermore does the stabilization module help to stabilize special actions such as kicks or get-up motions.

It was shown that this approach is easy to integrate in both hardware and software and therefore could potentially be used to improve the performance of other humanoid robots.

The system has successfully been demonstrated on the two current robot models used by the Darmstadt Dribblers to win the RoboCup humanoid kid-size league, technical challenge and the Louis Vuitton Best Humanoid Award 2009.

Ongoing work that is related to the topic of this paper includes detection of instability and falling prevention by emergency actions as well as an approach to assisted or even semi-automatic calibration of the robots' servo motors.

For the purpose of detecting instability the additional use of accelerometer data in fusion with the gyroscope data leads to a more precise and robust calculation of the robot's attitude, hereby adding the requirement for a two-axis accelerometer.

Similarly the semi-automatic calibration will need additional sensors. Viable candidates are the already existing vision system or possibly foot ground reaction force sensors.

## REFERENCES

- [1] M. Friedmann, S. Petters, M. Risler, H. Sakamoto, D. Thomas, and O. von Stryk, "New Autonomous, Four-Legged and Humanoid Robots for Research and Education," in *Workshop Proceedings of SIMPAR 2008, Intl. Conf. on Simulation, Modeling and Programming for Autonomous Robots*, E. Menegatti, Ed., Venice (Italy), November 3-4 2008, pp. 570-579. [Online]. Available: <http://www.simpar-conference.org/>
- [2] M. Friedmann, J. Kiener, S. Petters, H. Sakamoto, D. Thomas, and O. von Stryk, "Versatile, high-quality motions and behavior control of humanoid robots," *International Journal of Humanoid Robotics*, vol. 5, no. 3, pp. 417-436, September 2008.
- [3] R. B. McGhee and A. A. Frank, "On the stability properties of quadruped creeping gaits," *Mathematical Biosciences*, vol. 3, no. 1-2, pp. 331 - 351, 1968. [Online]. Available: <http://www.sciencedirect.com/science/article/B6VHX-45GVXJH-V/2/6b9f0f25136312f58ca484ced6a1aec>
- [4] M. Vukobratović and B. Borovac, "Zero Moment Point - Thirty Five Years of its Life," *International Journal of Humanoid Robotics*, vol. 1, no. 1, pp. 157-173, 2004.
- [5] A. Goswami, "Postural Stability of Biped Robots and the Foot-Rotation Indicator (FRI) Point," *The International Journal of Robotics Research*, vol. 18, no. 6, pp. 523-533, 1999. [Online]. Available: <http://ijr.sagepub.com/cgi/content/abstract/18/6/523>
- [6] M. Buss, M. Hardt, J. Kiener, M. Sobotka, M. Stelzer, O. von Stryk, and D. Wollherr, "Towards an autonomous, humanoid, and dynamically walking robot: modeling, optimal trajectory planning, hardware architecture, and experiments," in *Third IEEE International Conference on Humanoid Robots*. Karlsruhe, München: Springer Verlag, Sept. 30 - Oct. 3 2003.
- [7] J. J. Kuffner, Jr., S. Kagami, K. Nishiwaki, M. Inaba, and H. Inoue, "Dynamically-stable motion planning for humanoid robots," *Auton. Robots*, vol. 12, no. 1, pp. 105-118, 2002.
- [8] C. M. A. Pinto and M. Golubitsky, "Central pattern generators for bipedal locomotion," *J. of Mathematical Biology*, vol. 53, pp. 474-489, 2006.
- [9] C. Niehaus, T. Röfer, and T. Laue, "Gait Optimization on a Humanoid Robot using Particle Swarm Optimization," in *Proc. of the 2nd Workshop on Humanoid Soccer Robots*, 2007.
- [10] S. Behnke, "Online Trajectory Generation for Omnidirectional Biped Walking," in *Proc. of the 2006 IEEE Intl. Conf. on Robotics and Automation (ICRA)*, 2006.

- [11] F. Faber and S. Behnke, "Stochastic Optimization of Bipedal Walking using Gyro Feedback and Phase Resetting," in *Proc. of 7th IEEE-RAS Conference on Humanoid Robots*, 2007.
- [12] H. Moballegh, G. Hohl, T. Landgraf, B. Fischer, T. Langner, T. Fassbender, S. Otte, K. Stoll, A. Tuchscherer, D. Steig, S. Heinrich, S. Mielke, D. Seifert, M. Kukulski, B. Kahlert, and R. Rojas, "Fumanoid Team Description 2009," 2009. [Online]. Available: <http://www.fumanoids.de/wp-content/uploads/2009/07/TDP2009Fumanoid.pdf>